



Specifications

PVE 2506

Vibro Hammer

USA

Dimensions in inches

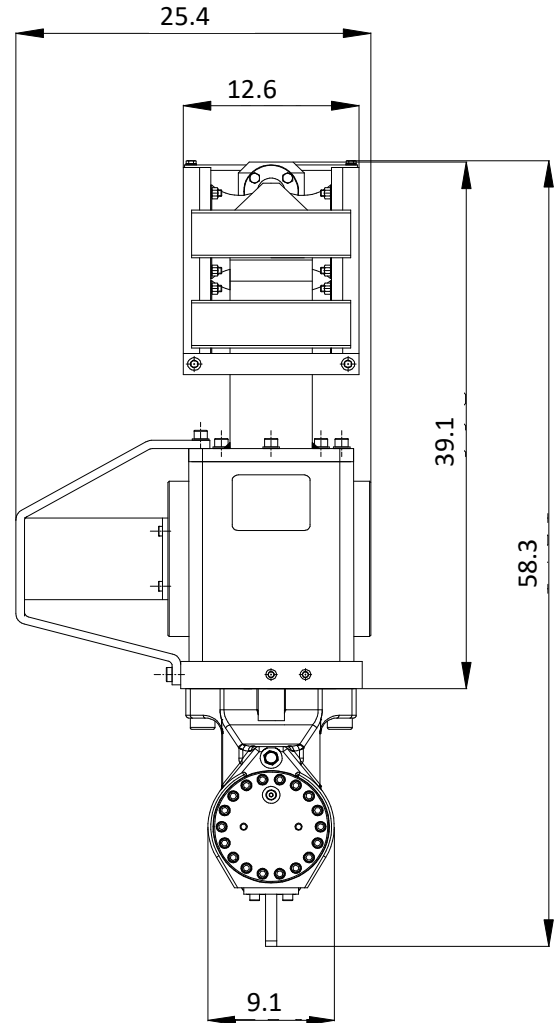
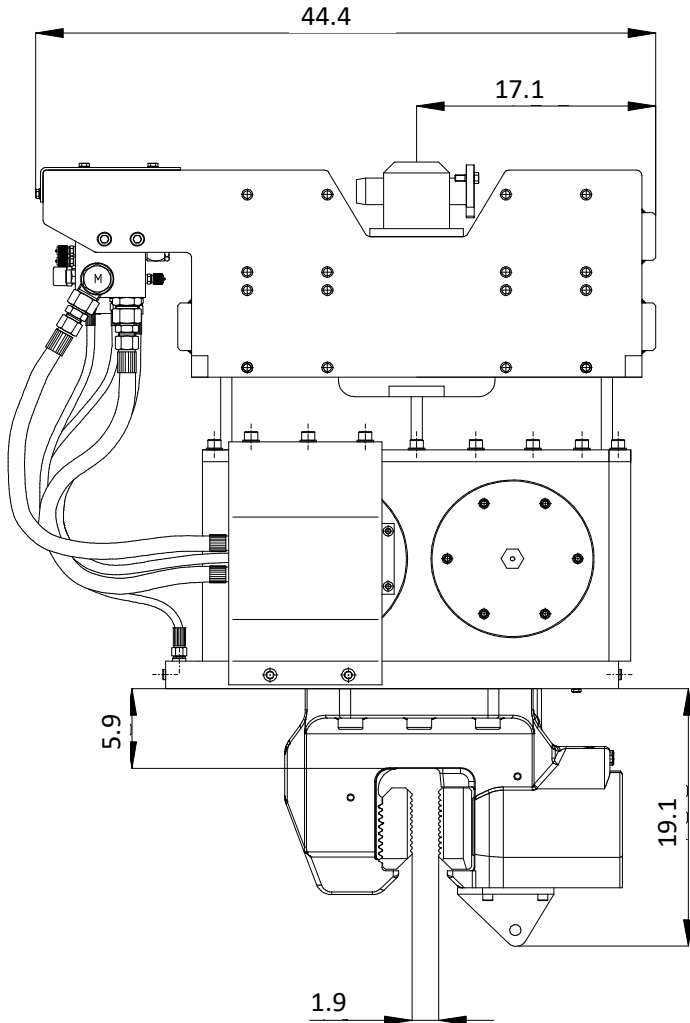

Specifications

PVE 2506

Eccentric moment	521 in-lbs	Clamps:	
Max. centrifugal force	46 ton	Sheet pile clamp	60TU
Max. frequency	2,500 rpm	Transport weight per piece	551 lbs
Max. amplitude excluding 60TU	0.72 in	Double clamps	N/A
Max. amplitude including 60TU	0.52 in	Transport weight per piece	N/A lbs
Max. static line-pull	12 ton		
Max. operating pressure	5,076 psi	Powerpack:	
Max. oil flow	53 gal/min	Model	N/A
Forced lubrication	no		
Dynamic weight excluding 60TU	1,455 lbs	Hose set:	
Dynamic weight including 60TU	2,006 lbs	Length	N/A ft
Total weight excluding 60TU & hoses	2,844 lbs	Transport weight (±)	N/A lbs